

c

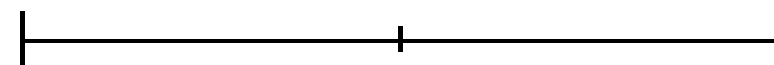

c



100 mm Scala H0 1:87

RIMESSA PENNE E MONTESILVANO
stato 1929

Tavola 1/4 © A. Lato

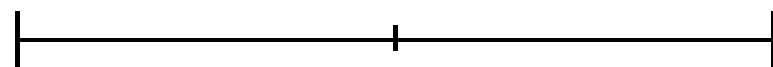
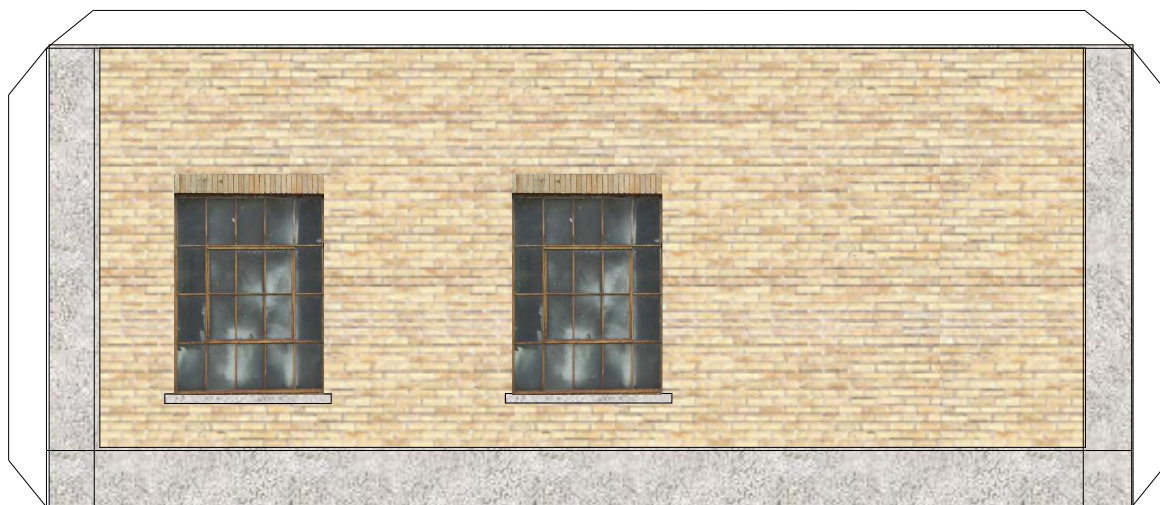

100 mm Scala H0 1:87

RIMESSA PENNE E MONTESILVANO
stato 1929

Tavola 2/4 © A. Lato

E

E

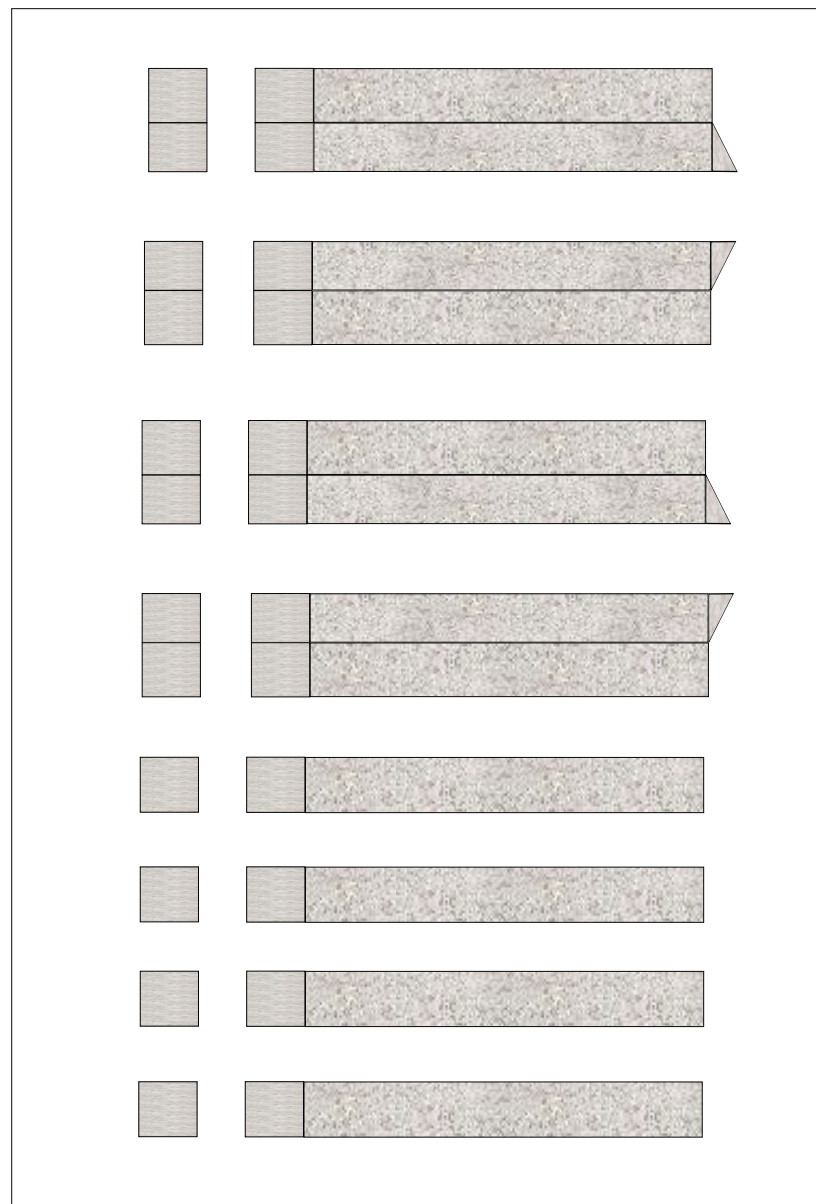

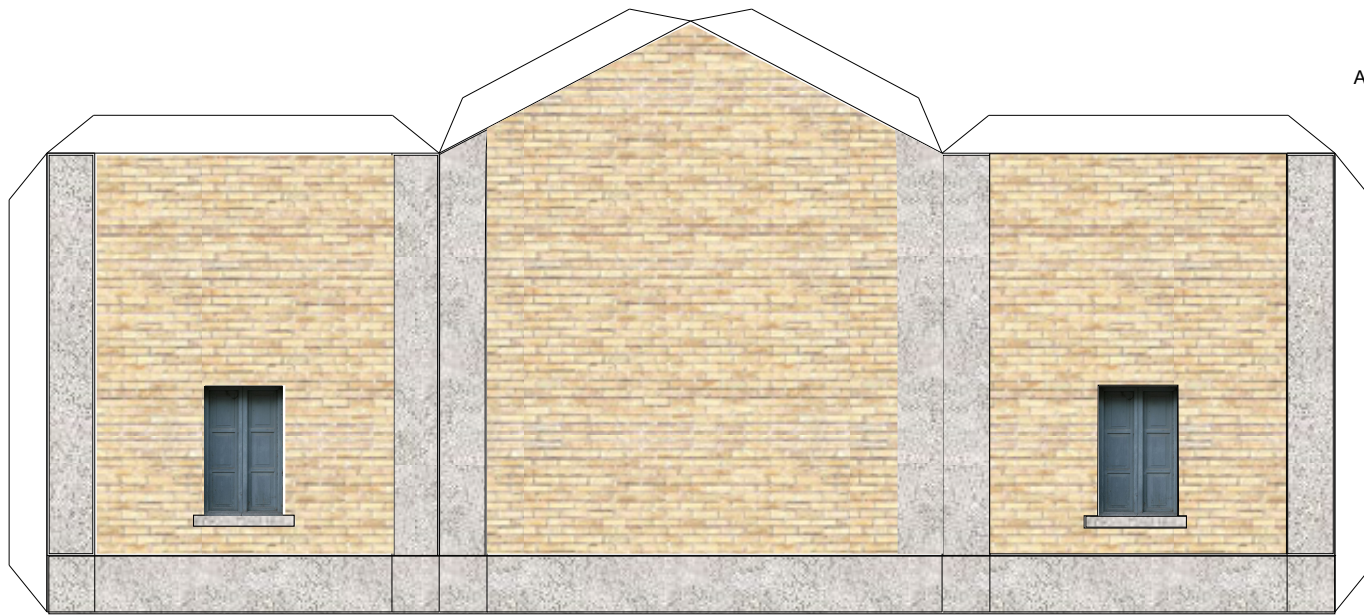

A

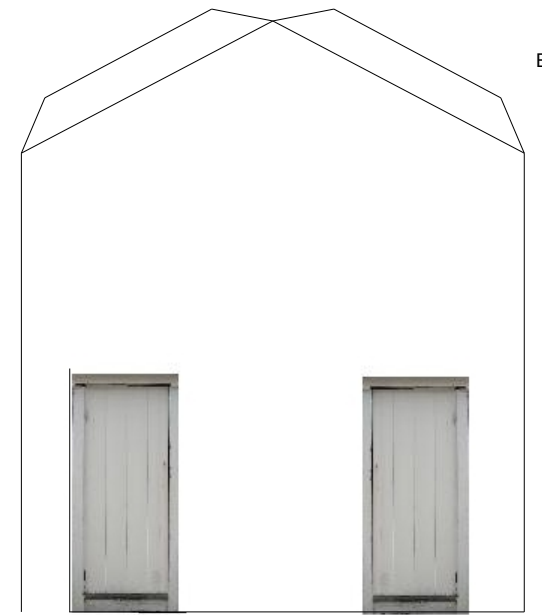

B

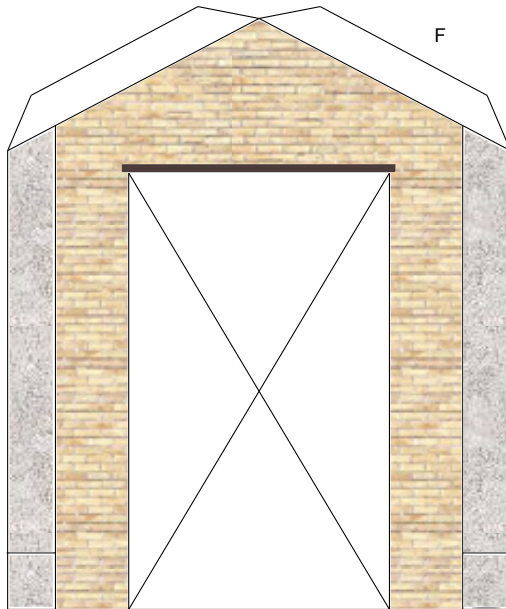

F

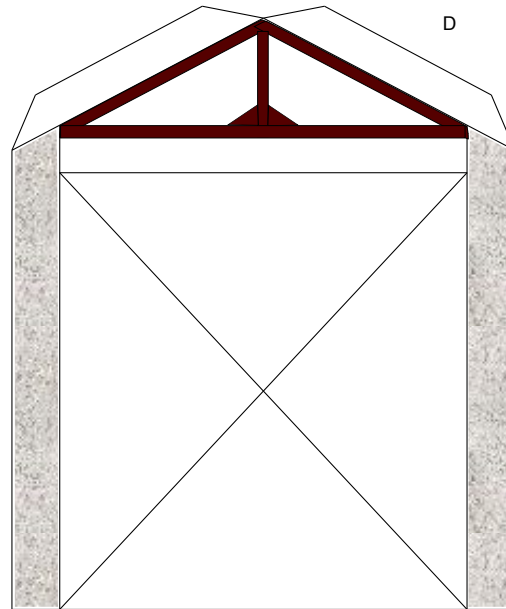

D

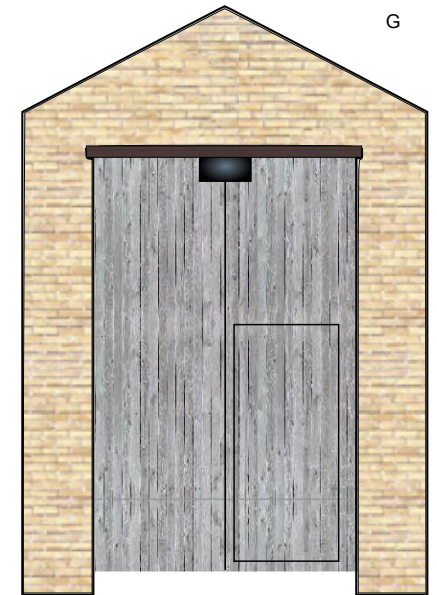

G

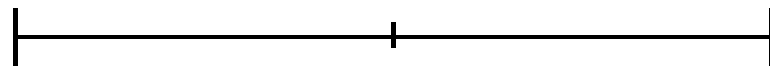

100 mm Scala H0 1:87

RIMESSA PENNE E MONTESILVANO
stato 1929

Tavola 3/4 © A. Lato

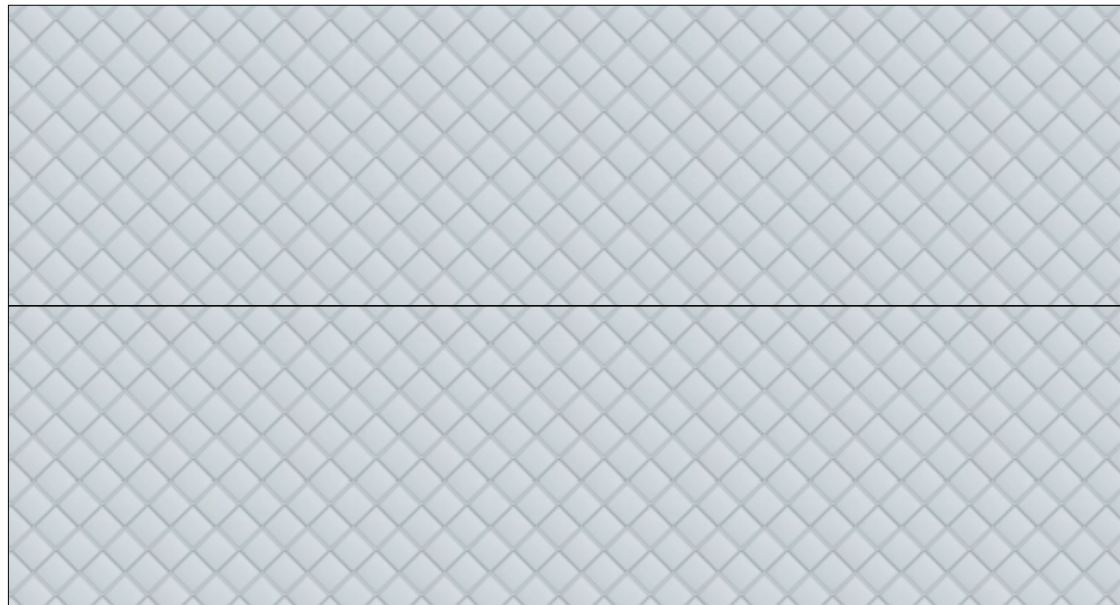
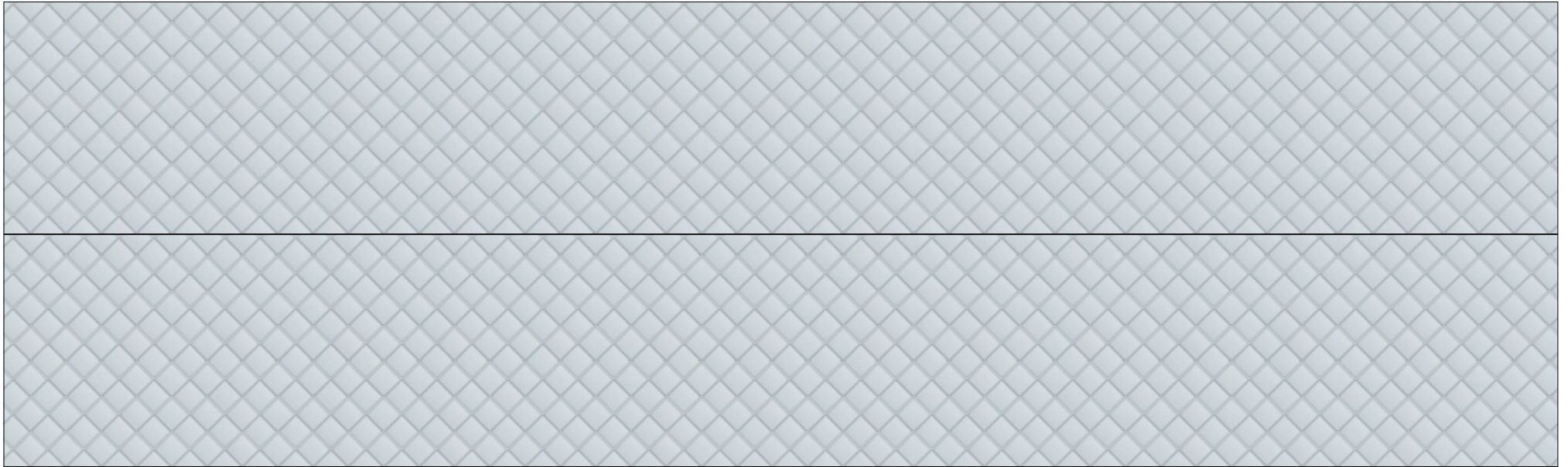

100 mm Scala H0 1:87

RIMESSA PENNE E MONTESILVANO
stato 1929

Tavola 4/4 © A. Lato

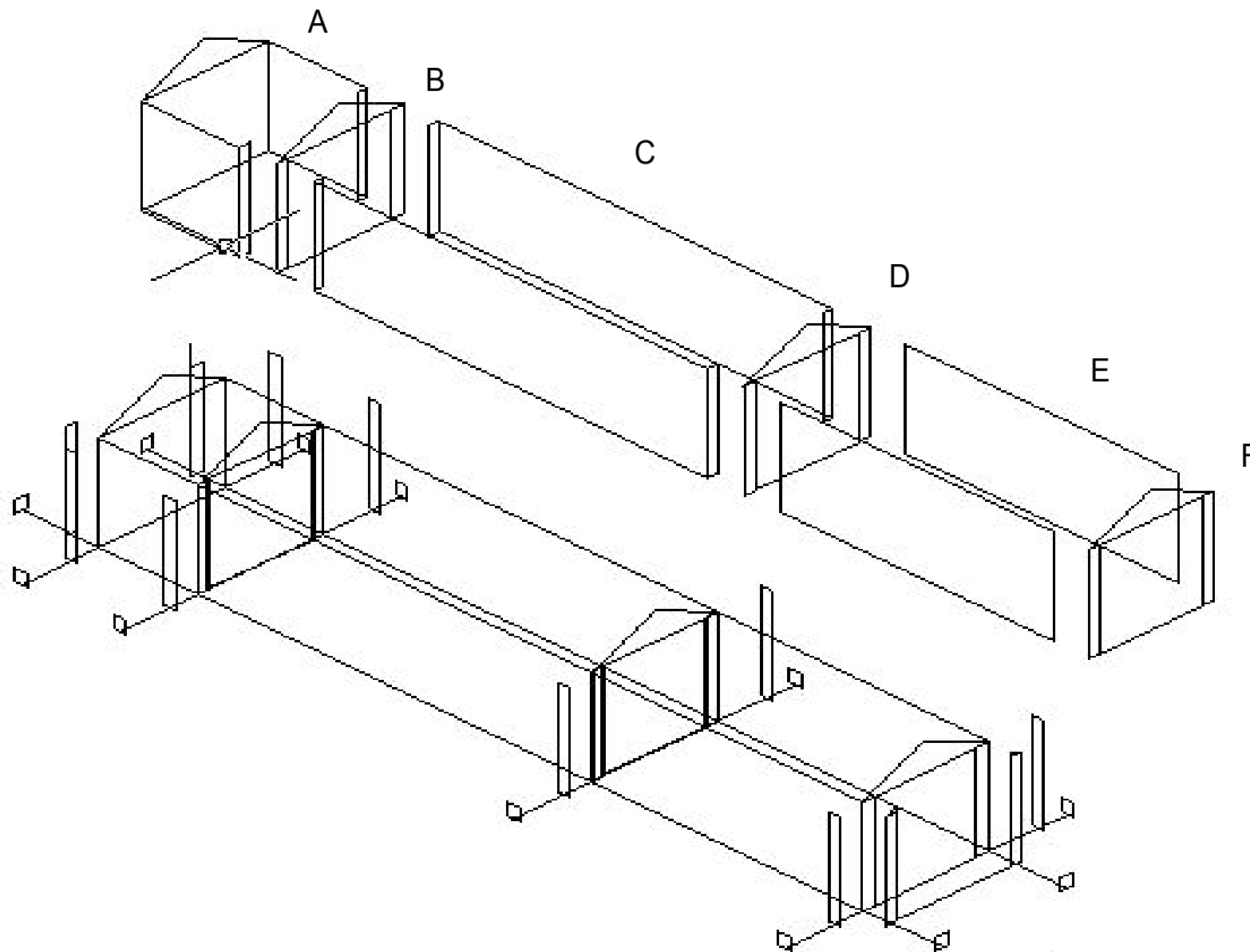

RIMESSA PENNE E MONTESILVANO
stato 1929

Schema Costruttivo © A. Lato